

Model : i-NS1220E

- 12x20mm Embedded FLEX LED NEON is Vertical bending with diameter of 200mm;
- It is made of Dow Chemical SILASTIC™ ET-7021 silicone rubber, which provides high transparency and high strength, environmental protection grade silicone material;
- It's integrated extrusion molding process, uniform lighting surface and no shadow;
- IP44 protection level, salt solution resistance, acids & alkalis, corrosive gases, fire and UV;
- 3 & 5 years warranty are available, Surface frosting process is optional.

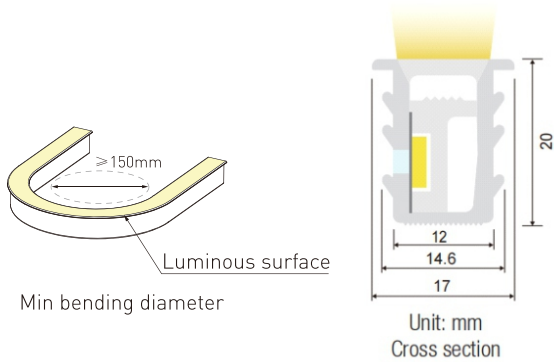

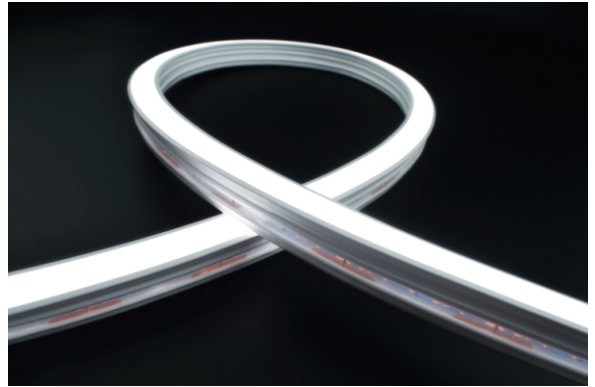
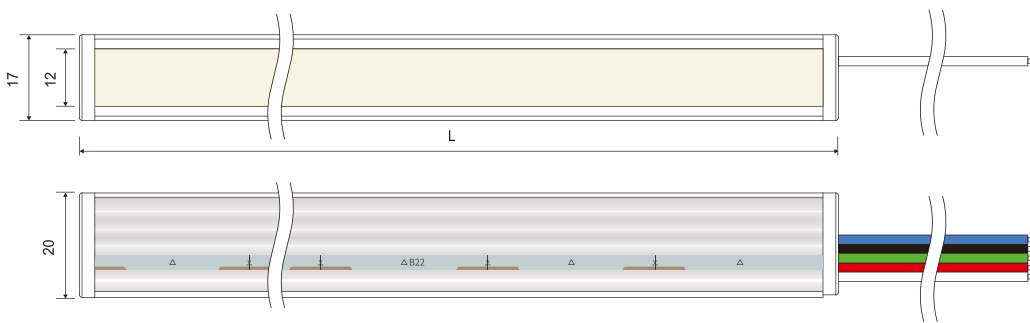

Dimension



Technical Data

CCT(K)	2400K ,2700K , 3000K , 4000K , 5800K Red , Green , Blue , Yellowr , Orange , Pink
Working Voltage	DC24V
CRI	>90
LED PIN Temperature	Max. 65 C
Storage Temperature	-25 C ~60 C
Ambient Temperature	Min.-25°C ,Max [Table below]
LEDNEON 1220	Low Output
Power[W/m]	10W
Max.Ambient tempt.(Ta _{max})	45 C

	 Single color	 CCT Tunable	 RGB	 RGBW
CCT(K)	3000K±150	WW+W2700K+6000K	RGB	RGB+WW(3000K)
CRI	≥90	≥90	--	>90
Voltage	DC24V	DC24V	DC24V	DC24V
Power(W)	10	10	10	10
Lumen(LM/M)	370	462	254	302
Unit Length (mm)	50	71.4	83.33	83.33
Max. Run Length(M)	17(CC)	5	5	5
CC/CV	CC/CV	CV	CV	CV

Note:

- Max. run length refers to single side feed in serial connection.
- The given data are typical values due to the tolerances of the production process and the electrical components, values for light output and electrical power can vary up to 10%.
- The given color temperature is the temperature of finished product.

 Voltage 24v DC	 UV Protection	 Consistency One Bin
 Length 5M	 Waterproof Grade IP 44	 Warranty 3 Years

