

## Model : i-NS1615E

- 16x15mm Embedded FLEX LED NEON is Vertical bending with diameter of 200mm;
- It is made of Dow Chemical SILASTIC™ ET-7021 silicone rubber, which provides high transparency and high strength, environmental protection grade silicone material;
- It's integrated extrusion molding process, uniform lighting surface and no shadow;
- IP44 protection level, salt solution resistance, acids & alkalis, corrosive gases, fire and UV;
- 3 & 5 years warranty are available, Surface frosting process is optional.

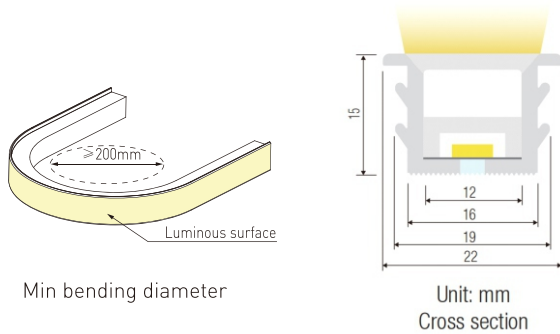

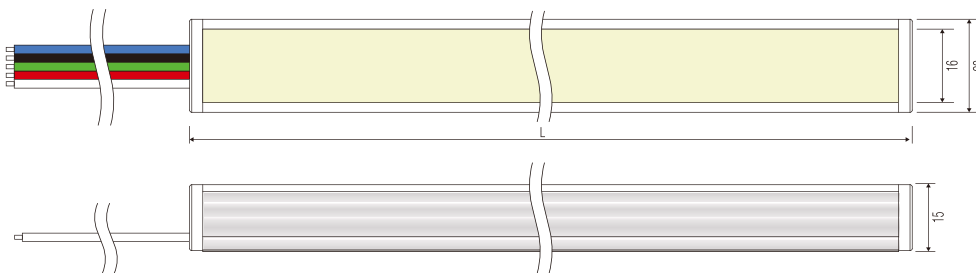



### Dimension





#### Technical Data

CCT(K)	2400K, 2600K, 3000K, 4100K, 6000K Red, Green, Blue, Yellow, Orange, Pink
Working Voltage	DC24V
CRI	>90
LED PIN Temperature	Max. 65 C
Storage Temperature	-25 C ~ 60 C
Ambient Temperature	Min. -25°C, Max ( Table below )
<b>LEDNEON 1615T</b>	<b>Low Output</b>
Power(W/m)	10W
Max.Ambient tempt.(T <sub>max</sub> )	45 C

	 Single color	 CCT Tunable	 RGB	 RGBW
CCT(K)	3000K±150	WW+W2700K+6300K	RGB	RGB+WW(3000K)
CRI	≥ 90	≥ 90	--	>90
Voltage	DC24V	DC24V	DC24V	DC24V
Power(W)	10	10	10	10
Lumen(LM/M)	607	674	419	505
Unit Length (mm)	50	71.4	83.33	83.33
Max. Run Length(M)	17(CC)	5	5	5
CC/CV	CC/CV	CV	CV	CV

Note:

- Max. run length refers to single side feed in serial connection.
- The given data are typical values due to the tolerances of the production process and the electrical components, values for light output and electrical power can vary up to 10%.
- The given color temperature is the temperature of finished product.

 Voltage <b>24v DC</b>	 UV <b>Protection</b>	 Consistency <b>One Bin</b>
 Length <b>5M</b>	 Waterproof Grade <b>IP 44</b>	 Warranty <b>3 Years</b>

